

PALTEK ***(OTC:7587)***

Fiscal Year 2001
Quarter One

Agenda

- Network Infrastructure Trends
- Semiconductor Market Trends
- First Quarter Results (FY2001 Jan-Mar)
- Fiscal Year 2001
 - Business Conditions & Issues
- Subsidiary Companies

Part I -- Network Infrastructure
(ネットワーク機器市場動向)

FY2001 First Quarter Results

PALTEK CORPORATION

April 13, 2001

Part II -- Semiconductor Market
(半導体業界動向)

FY2001 First Quarter Results

PALTEK CORPORATION

April 13, 2001

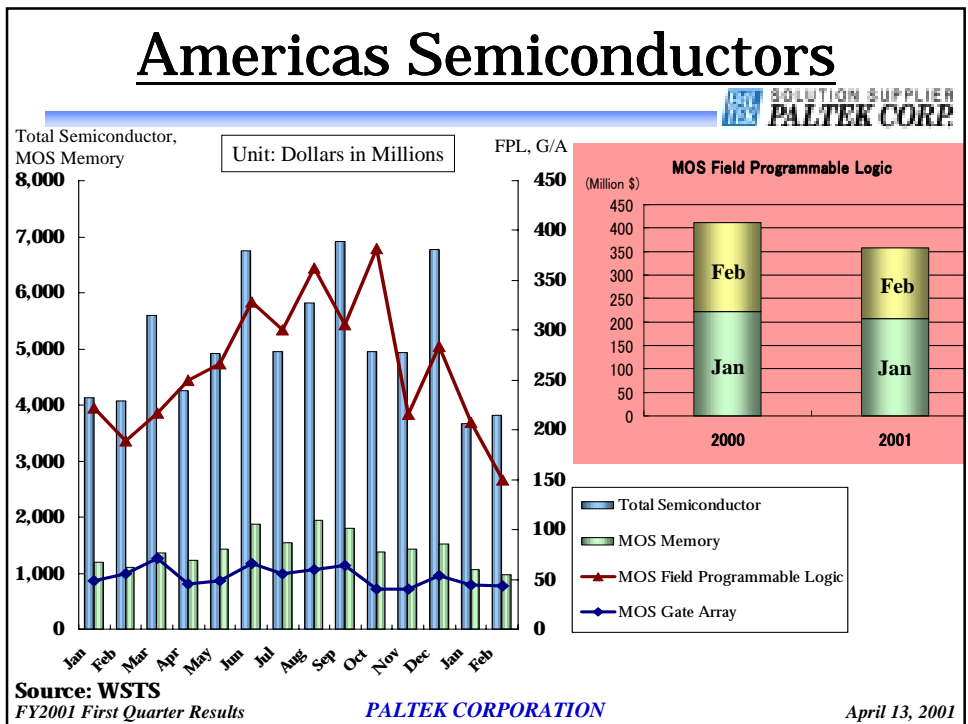
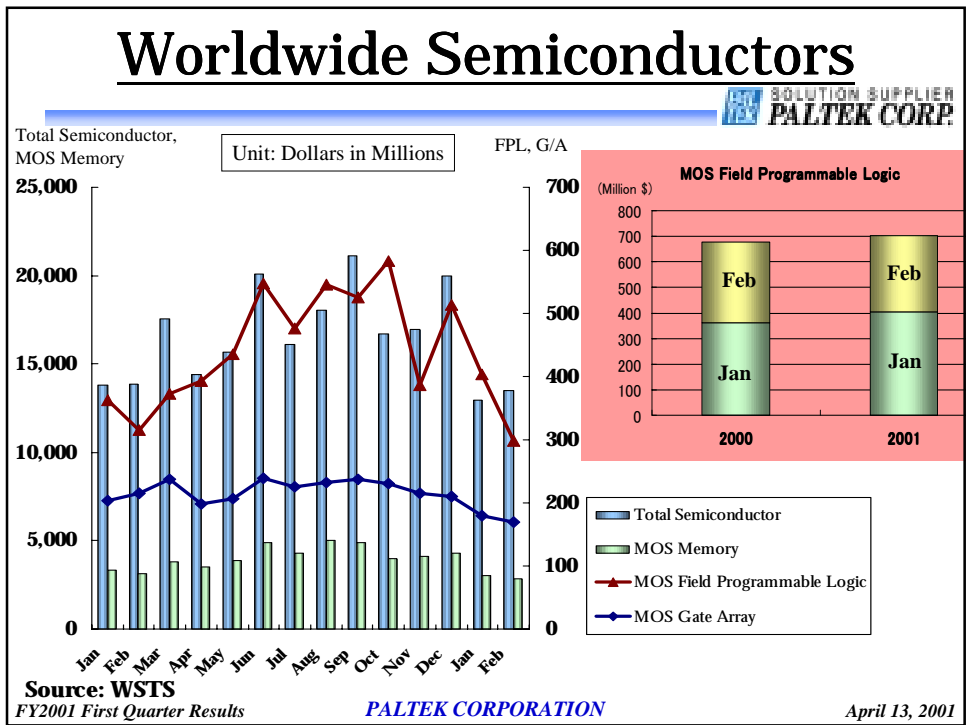

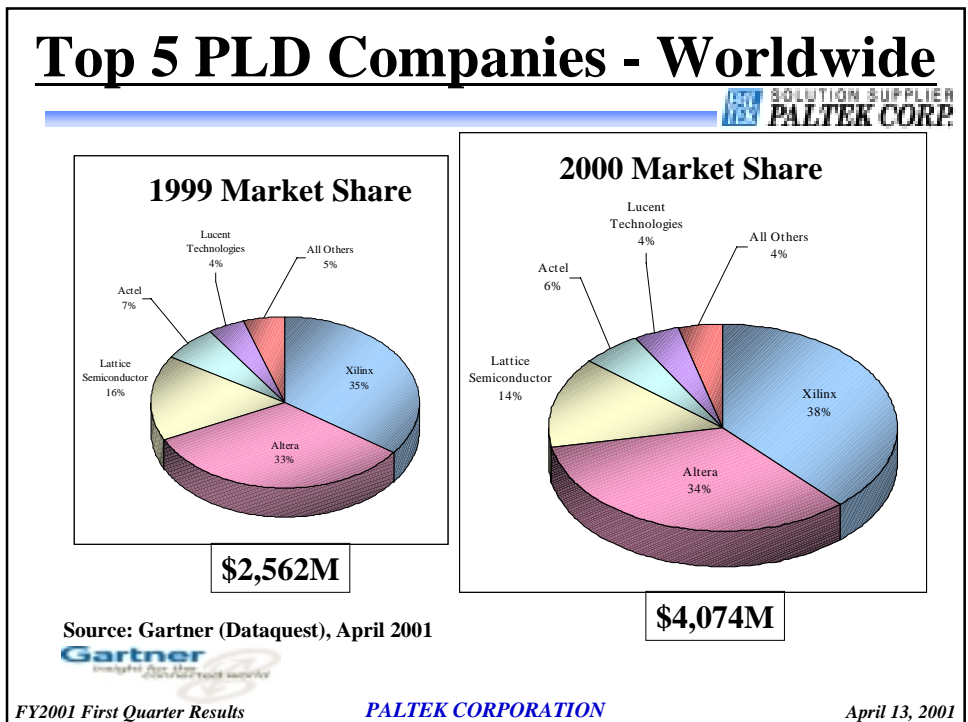
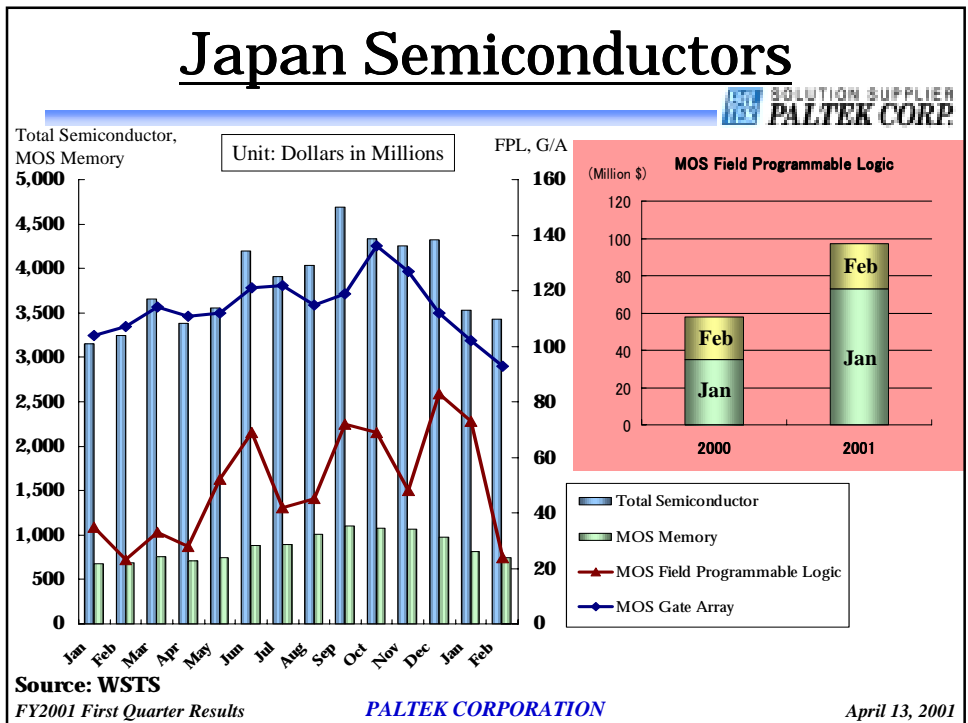

Top 5 PLD Companies - Japan

SOLUTION SUPPLIER
PALTEK CORP.

1999 Market Share

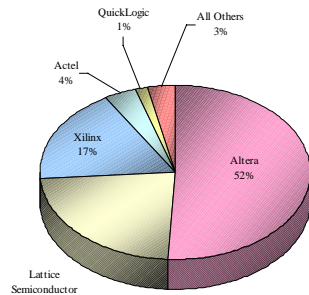

\$311M

2000 Market Share

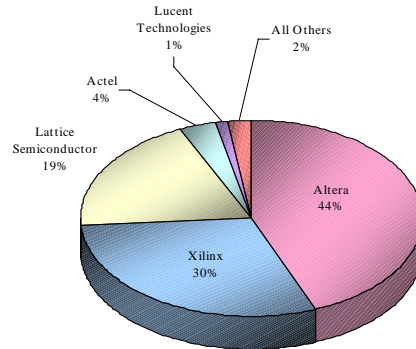

\$473M

Source: Gartner (Dataquest), April 2001



FY2001 First Quarter Results

PALTEK CORPORATION

April 13, 2001

SOLUTION SUPPLIER
PALTEK CORP.

Part III -- Year 2000 Results

(2001年度第1四半期(1-3月)業績結果)

FY2001 First Quarter Results

PALTEK CORPORATION

April 13, 2001

First Quarter Results

 SOLUTION SUPPLIER
PALTEK CORP.

- **Consolidated Sales: ¥5,260 Million**
- **Non-Consolidated Sales: ¥4,169 Million**
– Annual Growth (+25%)

FY2001 First Quarter Results

PALTEK CORPORATION

April 13, 2001

Revenue Growth

 SOLUTION SUPPLIER
PALTEK CORP.

Unit: Yen in Millions

NON-CONSOLIDATED

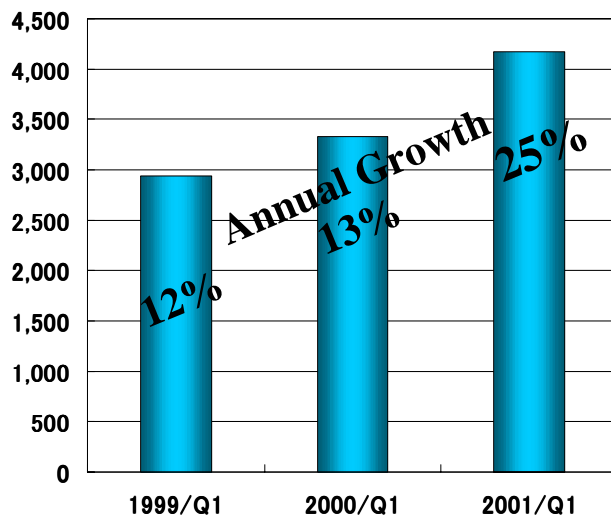

¥4,169M

FY2001 First Quarter Results

PALTEK CORPORATION

April 13, 2001

Sales Breakdown

SOLUTION SUPPLIER
PALTEK CORP.

NON-CONSOLIDATED

- **PLD Solutions**
80% (Annual Growth 20%)
- **NETWORK Solutions**
20% (Annual Growth 60%)

FY2001 First Quarter Results

PALTEK CORPORATION

April 13, 2001

Sales to Customers Breakdown

SOLUTION SUPPLIER
PALTEK CORP.

NON-CONSOLIDATED

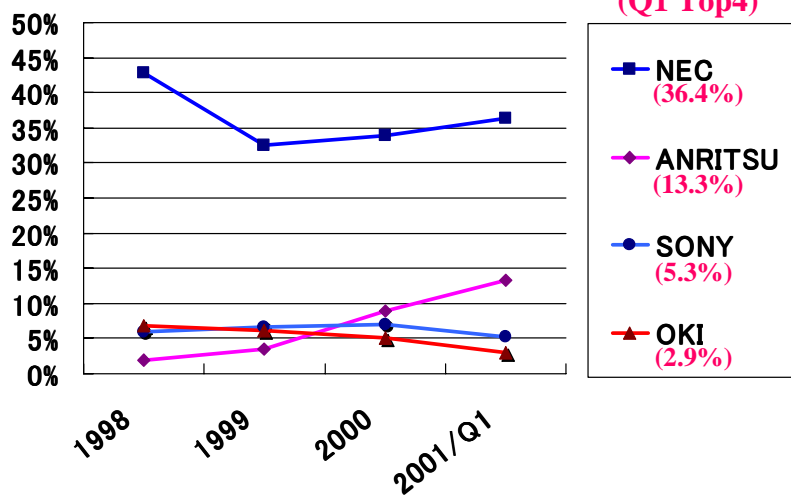

FY2001 First Quarter Results

PALTEK CORPORATION

April 13, 2001

Part IV -- Business Issues and Objectives
(2001年度第1四半期(1-3月)の状況)

FY2001 First Quarter Results

PALTEK CORPORATION

April 13, 2001

Business Issues

- **Inventory**
- **Foreign Exchange**

FY2001 First Quarter Results

PALTEK CORPORATION

April 13, 2001

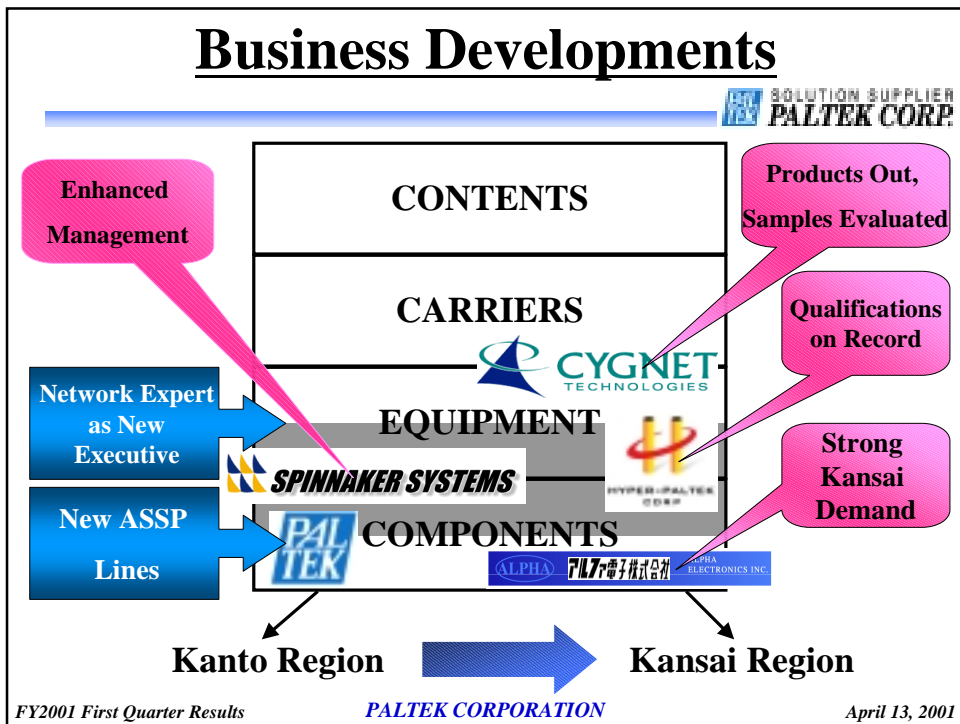
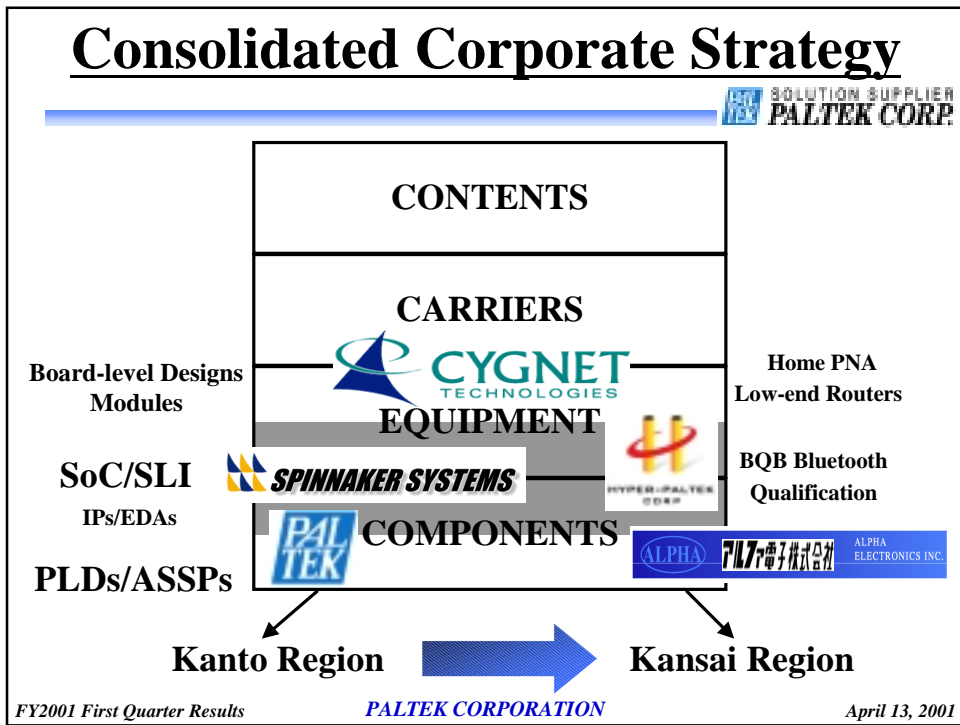

Business Objectives



- Convergence & Integration of PLDs & ASSPs
 - Reorganization of Organization
- New Executives & Management Team
- New Business Development
 - Parent Level, Semiconductor Business
 - New Suppliers and Increased Value-added Support
 - Consolidated Level
 - System-on-Chip
 - Network Equipment
 - Bluetooth Qualification

FY2001 First Quarter Results

PALTEK CORPORATION

April 13, 2001



New ASSP Lines



- Company:** PLX Technology, Inc.
- Website:** www.plxtech.com
- Founded:** 1986
- Located:** Sunnyvale, California
- Listed:** Nasdaq: PLXT
- Revenues:** \$65 Million in 2000
- Solutions:** High-speed interconnect silicon & software,
for PCI-based designs (Industry standard)
(PCI - Peripheral Component Interconnect)
- Customers:** Communication Equipment Makers
(Cisco, Lucent, Nortel, etc.)



FY2001 First Quarter Results

PALTEK CORPORATION

April 13, 2001



New ASSP Lines

 SOLUTION SUPPLIER
PALTEK CORP.

- Company:** NETsilicon, Inc.
Website: www.netsilicon.com
Founded: 1984
Located: Waltham, Massachusetts
Listed: Nasdaq: NSIL
Revenues: \$38 Million in 2000 (est.)
Solutions: Ethernet Microprocessing Solutions Package
Ethernet Interface (ARM + Ethernet)
Connecting equipment to Network/Ethernet
Customers: Nortel Networks, NEC, Kyocera, Ricoh, Sharp,
Mitsubishi Electric, Minolta, Konica, etc.

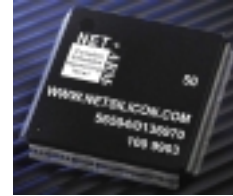

FY2001 First Quarter Results

PALTEK CORPORATION

April 13, 2001

 SOLUTION SUPPLIER
PALTEK CORP.

Part V -- Subsidiary Companies (PALTEKグループの状況)

FY2001 First Quarter Results

PALTEK CORPORATION

April 13, 2001

Alpha Electronics

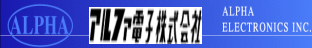

<http://www.alpha-denshi.co.jp>

- **Record growth during Q1 (Oct-Dec, 2000)**
80% Annual Sales Growth
- **Strong digital consumer demand,**
customers like SANYO

FY2001 First Quarter Results

PALTEK CORPORATION

April 13, 2001

Spinnaker Systems



<http://www.spinnaker.co.jp>

- **Reorganized Management**
 - Chairman Tadahito Takahashi
 - President & CEO Tsugumi Fujitani
 - Two other Directors
- **Enhanced Business & Management Strategy**
 - EDA
 - IP
 - SoC

FY2001 First Quarter Results

PALTEK CORPORATION

April 13, 2001

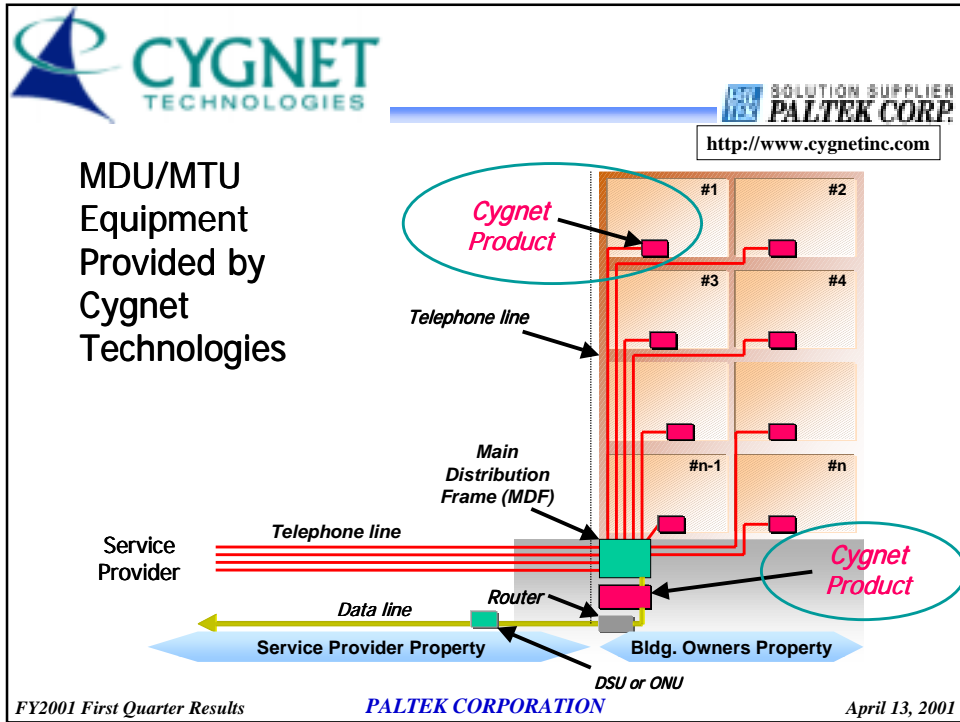

Japanese Market Opportunity

SOLUTION SUPPLIER
PALTEK CORP.

Residential

Apartments	Tenement Houses	Detached Houses
		
Total No: 16,457,500 Metro Area: 8,445,100 (51.3%) Total 1-7 Floor: 10,669,700 (64.83%) Total 8+ Floor: 2,698,900 (16.40%) Total 1-3 Floor (Wooden): 3,159,000 (19.19%)	Total No: 1,947,900 2+ Floors: 1,239,400 (63.6%)	Total No: 25,277,800 2+ Floors: 19,887,400 (78.7%)

CYGNET TECHNOLOGIES

FY2001 First Quarter Results
PALTEK CORPORATION
April 13, 2001



HYPER-PALTEK

SOLUTION SUPPLIER
PALTEK CORP.
<http://www.hyper-paltek.com>

Bluetooth Qualification Service Company

- 2 Products Qualified
 - Kenwood
 - CAR AUDIO



<http://qualweb.opengroup.org/Template.cfm?LinkQualified=QualifiedProducts>

- 10 Qualification Contracts Signed
 - Major Consumer Electronics Makers
 - Equipment, Components, and Modules

*FY2001 First Quarter Results**PALTEK CORPORATION**April 13, 2001*

SOLUTION SUPPLIER
PALTEK CORP.

Part VI -- Attachments

*FY2001 First Quarter Results**PALTEK CORPORATION**April 13, 2001*

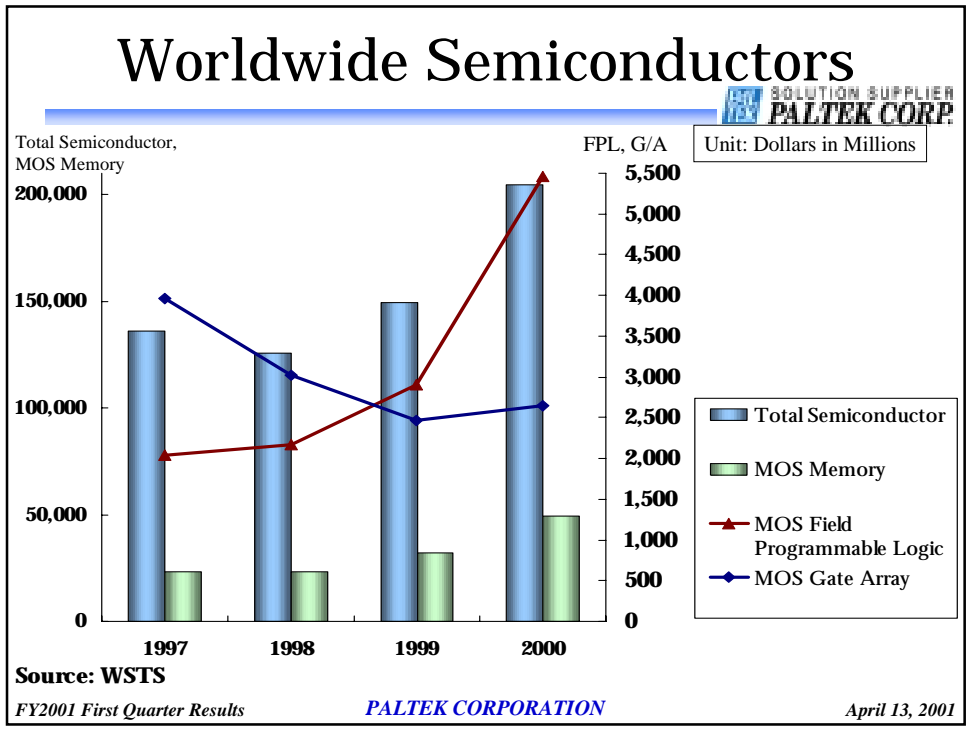
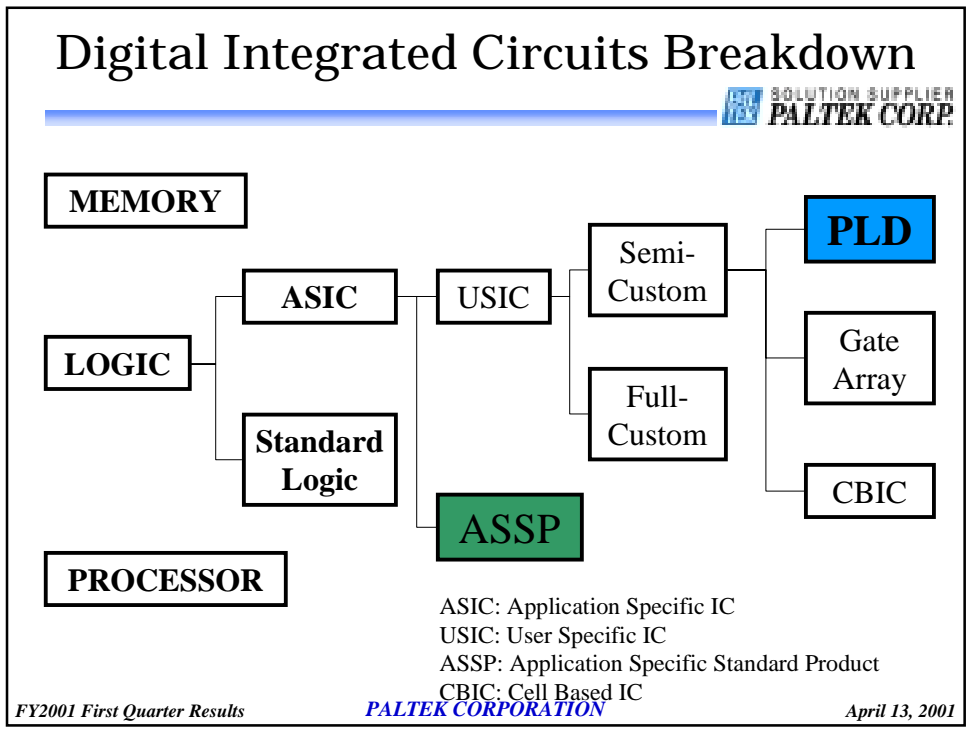

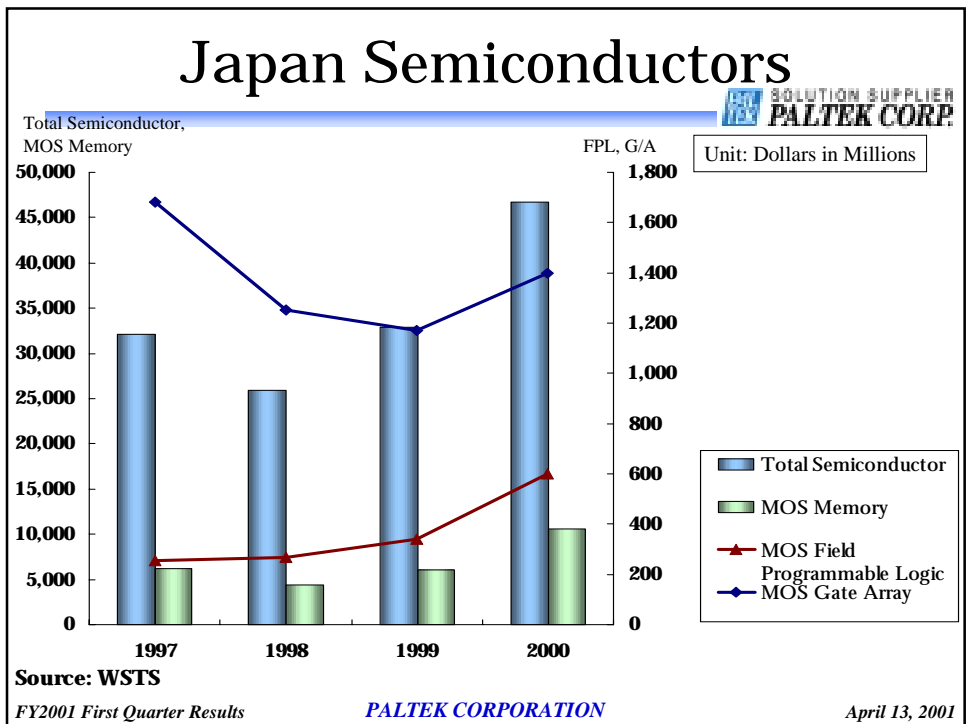
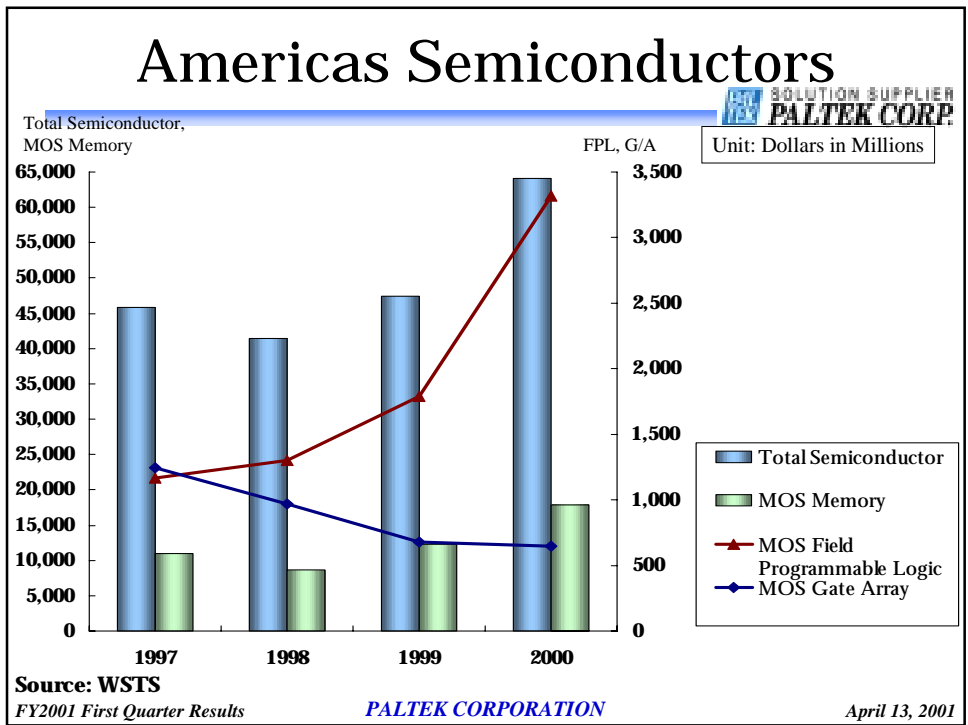

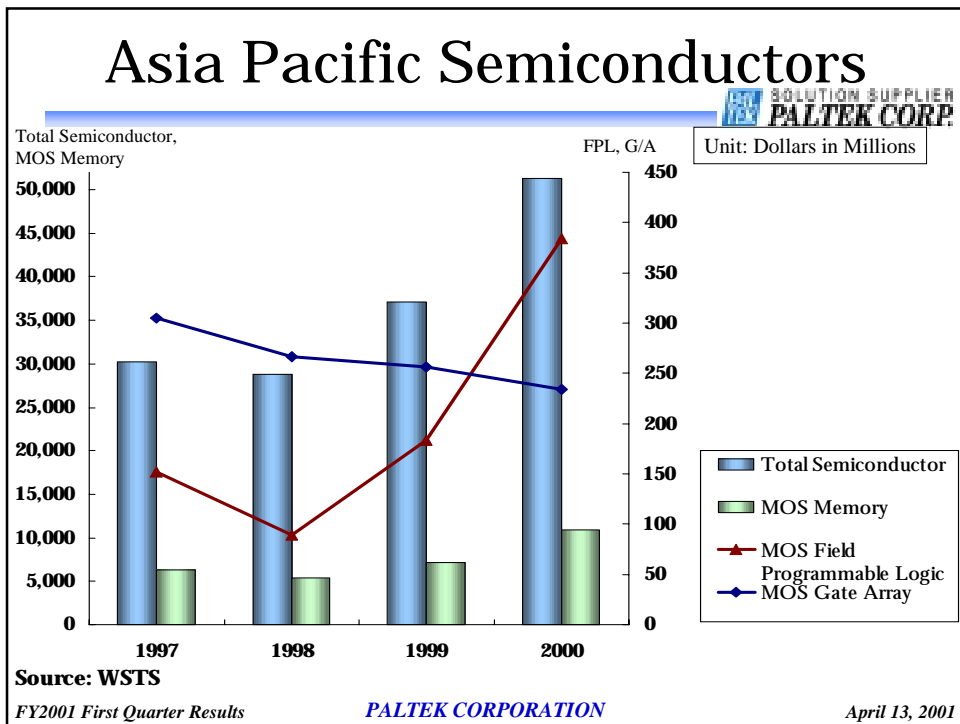
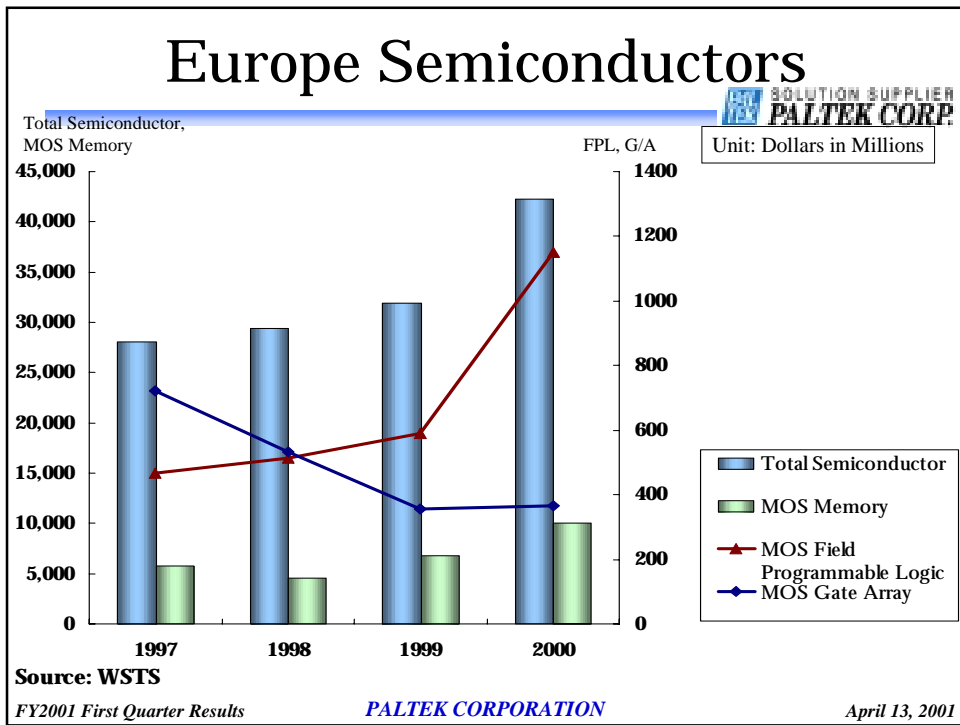

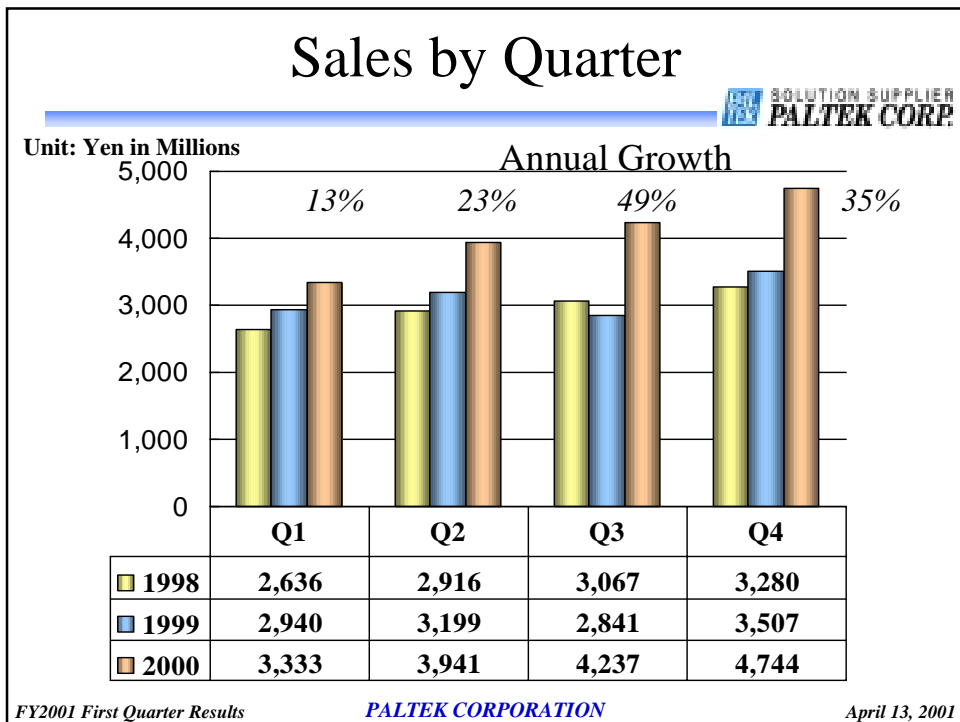
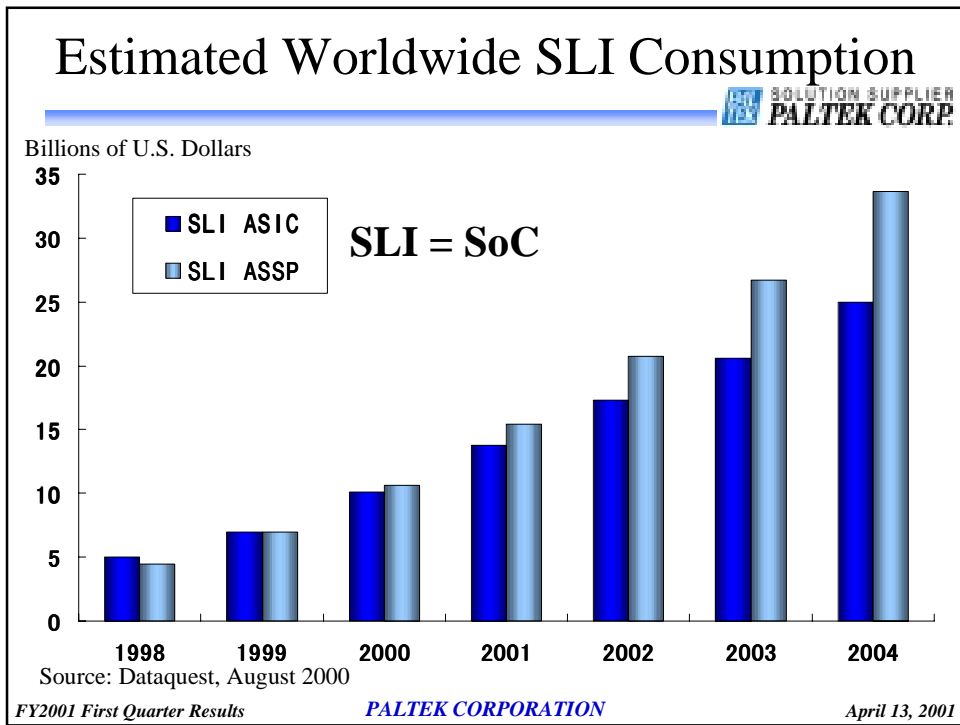

Safe Harbor Disclaimer



This presentation may provide projections or other forward-looking statements regarding future events and/or future financial performance. We wish to caution you that such statements are just predictions and that actual events or results may differ materially due to changes in the market and/or other business conditions.

FY2001 First Quarter Results

PALTEK CORPORATION

April 13, 2001

IR Contact



For Inquiries, please contact:

Daniel Brandt

Manager

Business Development & Investor Relations

PALTEK Corporation

2-3-12 Shin-Yokohama, Kouhoku-ku,
Yokohama 222-0033 Japan

TEL: +81-45-477-2016

FAX: +81-45-477-2012

E-mail: daniel@paltek.co.jp

FY2001 First Quarter Results

PALTEK CORPORATION

April 13, 2001